

PRODUCT DATASHEET

FL 100 P 69W 10KLM 865 PS SY100 BK

FLOODLIGHT 100 | Versatile floodlight with up to 10000 lm light output



PERFOR-
MANCE
CLASS

Areas of application

- Replacement for floodlights with halogen lamps
- Outdoor use (IP66)
- D-sign according to EN 60598-2-24 for fire-risk commercial unit, e.g. by accumulation of dust
- Public areas
- Building facades
- Construction areas
- Parking

Product benefits

- Breather membrane to optimize air exchange, without compromising IP protection
- Highly versatile due to selectable power steps (Multi Lumen) on the housing
- Robust cable gland with integrated waterstop function
- Safe and very uniform illumination, due to frosted and tempered glass diffuser
- Bright, robust and durable
- Energy savings of up to 90 % compared to halogen lamp floodlights
- No upper light output ratio (ULOR 0%) when mounted at 0° tilt

Product features

- High luminous efficacy: up to 150 lm/W
- Type of protection: IP66
- Pre-installed, flexible 1 m cable (H05RN-F), wrapped 3 x 1.0 mm² single wires
- Reflector-based, symmetric light distribution with 100° x 100° beam angle
- Mounting bracket with 30° angle and wide rotation area

TECHNICAL DATA

Electrical data

Nominal wattage	69 W / 53 W
Nominal voltage	220...240 V
Mains frequency	50...60 Hz
Nominal current	310 /
Inrush current	18.8 A
Inrush current time T_{h50}	86.2 μ s
Max. number of luminaires per miniature circuit breaker B16	40
Max. number of luminaires per miniature circuit breaker C10	25
Max. number of luminaires per miniature circuit breaker C16	25
Power factor λ	> 0.90
Total harmonic distortion	< 20 %
Protection class	I
Surge capability (L-N)	4 kV
Surge capability (L/N-Ground)	6 kV
Operating mode	Integrated LED driver

Photometrical data

Luminous flux	10000 lm / 8000 lm
Luminous efficacy	145 lm/W
Color temperature	6500 K
Light color (designation)	Cool Daylight
Color rendering index Ra	80
Standard deviation of color matching	5 sdc _m
Stroboscope effect metric (SVM)	≤0.9
Photobiological safety group acc. to EN62778	RG1
Photobiological safety group acc. to EN62471	RG1
Beam angle	100 ° x 100 °

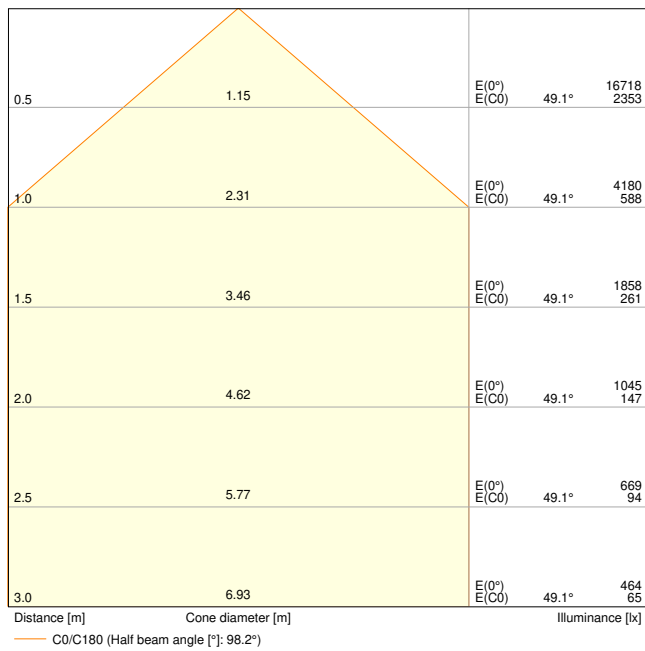

FL 100 P 69W 10KLM 865 PS SY100 BK

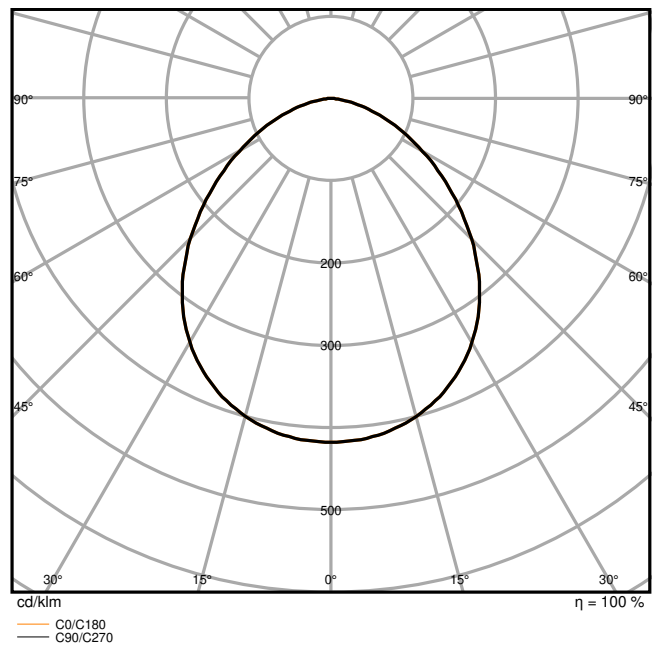

FL 100 P 69W 10KLM 865 PS SY100 BK

Dimensions & Weight

Length	236.00 mm
Width	52.00 mm
Height	236.00 mm
Product weight	1712.00 g
Cable length	1000 mm

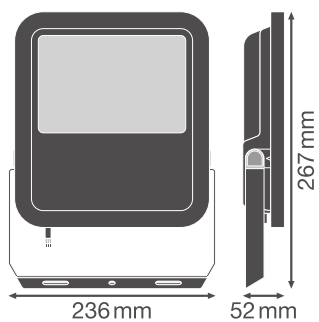

FL 100P SY100

Materials & Colors

Product color	Black
Housing color	Black

Body material	Aluminum
Cover material	Glass
Light emitting surface material	Glass
Glow Wire Test according to IEC 60695-2-12	650 °C
Mercury content	0.0 mg

Application & Mounting

Ambient temperature range	-30...+50 °C
Temperature range at storage	-40...+70 °C
Type of connection	Cable, 3-pole
Type of protection	IP66
Protection class IK (shock resistance)	IK08
Corrosion resistance class acc. to EN 12944	C4
Dimmable	No
Mounting type	Surface
Mounting location	Wall / Pole / Floor / Ceiling
Application environment	Outdoor
Adjustable	Yes
LED module replaceable	Not replaceable
With light source	Yes

Lifespan

Lifespan L70/B50 at 25 °C	100000 h ¹⁾
Lifespan L80/B10 at 25 °C	75000 h ¹⁾
Lifespan L90/B10 at 25 °C	35000 h

¹⁾ t[h]: L70 / B50 @ 25 °C (Ta), t[h]: L80 / B10 @ 25 °C (Ta), t[h]: L90 / B10 @ 25 °C (Ta)

Control gear

Output current	550 mA
ECG - Output ripple current	< 20 %

Certificates & Standards

Standards	CE / CB / ENEC / EAC / UKCA
Luminaire with limited surface temperature, "D sign"	Yes
Ball shot safe	No















Additional product data

Product remark	Available from September 2024
Added function	MULTI SELECT

Safety advice

– Max. wind load surface 0.045 m²

DOWNLOAD DATA

Documents and certificates		Document name
	User Instruction	G11193710_UI_Floodlight_65W-200W
	Legal information	LI_JQ_L2D1_T_G11195895
	Legal information	Insert_LSI_Floodlight_69W-167W_G11195968
	Legal information	Informationstext 18 Abs 4 ElektroG
	Declarations of conformity	FLOODLIGHT GEN4
	Declarations Of Conformity UKCA	FLOODLIGHT GEN4
Photometric and lighting design files		Document name
	IES file (IES)	FL 100 P 69W 10KLM 865 PS SY100 BK
	LDT file (Eulumdat)	FL 100 P 69W 10KLM 865 PS SY100 BK
	UGR file (UGR table)	FL 100 P 69W 10KLM 865 PS SY100 BK
	LDC typ cone	FL 100 P 69W 10KLM 865 PS SY100 BK
	LDC typ polar	FL 100 P 69W 10KLM 865 PS SY100 BK
CAD/BIM files		Document name
	BIM_Revit_3D	Floodlight G4
	CAD_STEP_3D	FL G4 69W
Tender texts		Document name
	Tender documents	FLOODLIGHT 100 69W 10KLM 865 PS SY100 BK-EN

LOGISTICAL DATA

Product code	Packaging unit (Pieces/Unit)	Dimensions (length x width x height)	Gross weight	Volume
4099854306204	Folding box 1	78 mm x 255 mm x 237 mm	1868.00 g	4.71 dm ³
4099854306211	Shipping box 4	332 mm x 271 mm x 264 mm	7976.00 g	23.75 dm ³

The mentioned product code describes the smallest quantity unit which can be ordered. One shipping unit can contain one or more single products. When placing an order, for the quantity please enter single or multiples of a shipping unit.

ADDITIONAL CATALOG INFORMATION

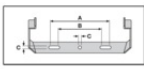

230 Vac								
A	B	C	IP	C RA	B RA	C RA		
69W	150	108	8.5	2x MB	0.045m ²	25	40	41
100W	150	108	10.5	2x MB	0.070m ²	6	5	9
133W	170	118	10.5	2x MB	0.085m ²	4	4	7
167W	170	118	12.5	2x M10	0.105m ²	4	4	7

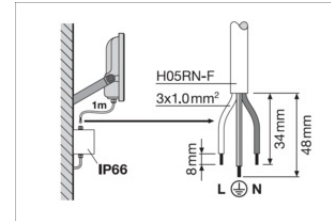
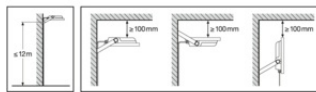

FL100P69W10KLM830PS SY100	53W/7320lm	69W/9150lm
FL100P69W10KLM840PS SY100	53W/8000lm	69W/10000lm
FL100P69W10KLM865PS SY100	53W/8000lm	69W/10000lm
FL150P100W15KLM830PS SY100	83W/11670lm	100W/14000lm
FL150P100W15KLM840PS SY100	83W/12500lm	100W/15000lm
FL150P100W15KLM865PS SY100	83W/12500lm	100W/15000lm
FL200P133W20KLM830PS SY100	117W/16275lm	133W/19600lm
FL200P133W20KLM840PS SY100	117W/17500lm	133W/20000lm
FL200P133W20KLM865PS SY100	117W/17500lm	133W/20000lm
FL250P167W25KLM830PS SY100	150W/21060lm	167W/23400lm
FL250P167W25KLM840PS SY100	150W/22500lm	167W/25000lm
FL250P167W25KLM865PS SY100	150W/22500lm	167W/25000lm

References / Links

- For Guarantee see www.ledvance.com/guarantee

DISCLAIMER

Subject to change without notice. Errors and omission excepted. Always make sure to use the most recent release.