

PRODUCT DATASHEET

FL 200 PCELL P 133W 840 20KLM PS BK

FLOODLIGHT PHOTOCELL 200 | Floodlight with daylight sensor, up to 20000 lm



Areas of application

- Replacement for floodlights with halogen lamps
- Outdoor use (IP66)
- D-sign according to EN 60598-2-24 for fire-risk commercial unit, e.g. by accumulation of dust
- Public areas
- Building facades
- Construction areas
- Parking

Product benefits

- Automatically switches on and off according to the amount of available daylight
- Always-on override, activated via special mains switching pattern
- Breather membrane to optimize air exchange, without compromising IP protection
- Highly versatile due to selectable power steps (Multi Lumen) on the housing
- Robust cable gland with integrated waterstop function
- Safe and very uniform illumination, due to frosted and tempered glass diffuser
- Bright, robust and durable
- No upper light output ratio (ULOR 0%) when mounted at 0° tilt
- Energy savings of up to 90 % compared to halogen lamp floodlights

Product features

- Daylight sensor, integrated in glass cover
- Switch on below 35 lux, switch off above 95 lux illuminance
- High luminous efficacy: up to 150 lm/W
- Type of protection: IP66
- Pre-installed, flexible 1 m cable (H05RN-F), wrapped 3 x 1.0 mm² single wires
- Reflector-based, symmetric light distribution with 100° x 100° beam angle
- Mounting bracket with 30° angle and wide rotation area
- Integrated voltage driver, suitable for 220 - 240 V AC

TECHNICAL DATA

Electrical data

Nominal wattage	133 W / 117 W
Nominal voltage	220...240 V
Mains frequency	50...60 Hz
Nominal current	590 /
Inrush current	34.6 A
Inrush current time T_{h50}	552 μ s
Max. number of luminaires per miniature circuit breaker B16	4
Max. number of luminaires per miniature circuit breaker C10	4
Max. number of luminaires per miniature circuit breaker C16	7
Power factor λ	> 0.90
Total harmonic distortion	< 20 %
Protection class	I
Surge capability (L-N)	4 kV
Surge capability (L/N-Ground)	6 kV
Operating mode	Integrated LED driver

Photometrical data

Luminous flux	20000 lm / 17500 lm
Luminous efficacy	150 lm/W
Color temperature	4000 K
Light color (designation)	Cool White
Color rendering index Ra	80
Standard deviation of color matching	5 sdc _m
Stroboscope effect metric (SVM)	≤0.9
Photobiological safety group acc. to EN62778	RG1
Photobiological safety group acc. to EN62471	RG1
Beam angle	100 ° x 100 °

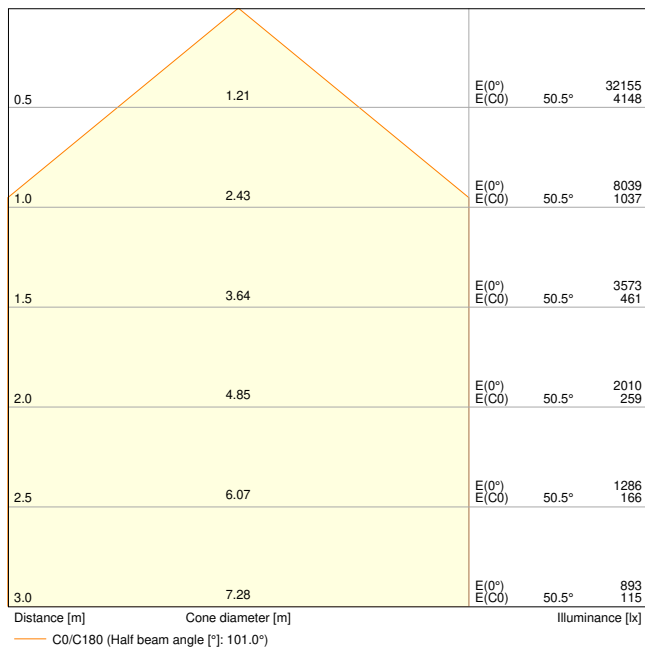

FL 200 PCELL P 133W 840 20KLM PS BK

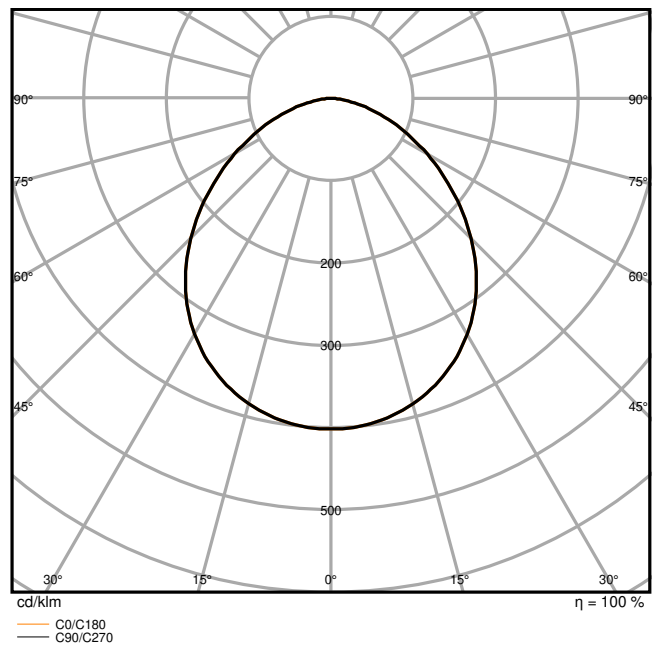

FL 200 PCELL P 133W 840 20KLM PS BK

Dimensions & Weight

Length	294.00 mm
Width	58.00 mm
Height	376.00 mm
Product weight	3484.00 g
Cable length	1000 mm

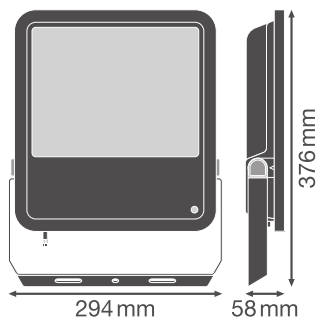

FL 200 PCELL 20KLM

Materials & Colors

Product color	Black
Housing color	Black

Body material	Aluminum
Cover material	Glass
Light emitting surface material	Glass
Glow Wire Test according to IEC 60695-2-12	650 °C
Mercury content	0.0 mg

Application & Mounting

Ambient temperature range	-30...+50 °C
Temperature range at storage	-40...+70 °C
Type of connection	Cable, 3-pole
Type of protection	IP66
Protection class IK (shock resistance)	IK08
Corrosion resistance class acc. to EN 12944	C4
Dimmable	No
Mounting type	Surface
Mounting location	Wall / Pole / Floor
Application environment	Outdoor
Adjustable	Yes
LED module replaceable	Not replaceable
With light source	Yes

Lifespan

Lifespan L70/B50 at 25 °C	100000 h ¹⁾
Lifespan L80/B10 at 25 °C	75000 h ¹⁾
Lifespan L90/B10 at 25 °C	35000 h

¹⁾ t[h]: L70 / B50 @ 25 °C (Ta), t[h]: L80 / B10 @ 25 °C (Ta), t[h]: L90 / B10 @ 25 °C (Ta)

Control gear

Output current	630 mA
ECG - Output ripple current	< 20 %

Sensor

Type of sensor	Light
Sensor technology	Photocell
Detection threshold of daylight sensor	35...95 lx
Sensor IP rating	IP66

Certificates & Standards

Standards	CE / CB / ENEC / EAC / UKCA
Luminaire with limited surface temperature, "D sign"	Yes

Ball shot safe	No
----------------	----







Additional product data





Product remark	Available from September 2024
Added function	MULTI SELECT



Safety advice

– Max. wind load surface 0.085 m²

DOWNLOAD DATA

Documents and certificates		Document name
	User Instruction	G11193709_UI_Floodlight_Photocell
	Legal information	LI_JQ_L2D1_T_G11195895
	Legal information	Insert_LSI_Floodlight_Sensor_Photocell_G11195969
	Legal information	Informationstext 18 Abs 4 ElektroG
	Declarations of conformity	FLOODLIGHT GEN4
	Declarations Of Conformity UKCA	FLOODLIGHT GEN4

Photometric and lighting design files		Document name
	IES file (IES)	FL 200 PCELL P 133W 840 20KLM PS BK
	LDT file (Eulumdat)	FL 200 PCELL P 133W 840 20KLM PS BK
	UGR file (UGR table)	FL 200 PCELL P 133W 840 20KLM PS BK
	LDC typ cone	FL 200 PCELL P 133W 840 20KLM PS BK
	LDC typ polar	FL 200 PCELL P 133W 840 20KLM PS BK

CAD/BIM files		Document name
	BIM_Revit_3D	Floodlight G4
	CAD_STEP_3D	FL G4 133W

Tender texts	Document name
 Tender documents	FLOODLIGHT PHOTOCELL 200 133W 840 20KLM PS BK-EN

LOGISTICAL DATA

Product code	Packaging unit (Pieces/Unit)	Dimensions (length x width x height)	Gross weight	Volume
4099854307041	Folding box 1	75 mm x 324 mm x 417 mm	3785.00 g	10.13 dm ³
4099854307058	Shipping box 2	340 mm x 167 mm x 444 mm	8069.00 g	25.21 dm ³

The mentioned product code describes the smallest quantity unit which can be ordered. One shipping unit can contain one or more single products. When placing an order, for the quantity please enter single or multiples of a shipping unit.

ADDITIONAL CATALOG INFORMATION

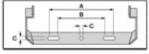

230 Vac							
A	B	C	Area (m ²)	C10A	B10A	C10A	
60W	150	8.5	2x-M8	0.045m ²	25	41	41
100W	150	10.5	2x-M8	0.070m ²	6	5	9
133W	170	11.8	2x-M8	0.085m ²	4	4	7

Product Code	Dimensions (mm)	Weight (g)
FL 100 PCELL P 80W 840 10KLM PS	55 W / 8000 mm	48 W / 15000 mm
FL 100 PCELL P 100W 840 10KLM PS	80 W / 12000 mm	100 W / 15000 mm
FL 100 PCELL P 133W 840 20KLM PS	117 W / 17000 mm	100 W / 20000 mm

References / Links

– For Guarantee see www.ledvance.com/guarantee

DISCLAIMER

Subject to change without notice. Errors and omission excepted. Always make sure to use the most recent release.