

IP40 LED batten

IP40 LED batten with opal diffuser for homogenous lighting for indoor applications. Protected design, time saving, tool-free locking mechanism ensuring protection against opening and manipulation. Easy tool based opening if required after installation. Easy upgrade to emergency operation with plug and play emergency kit. Total luminous flux: 6500 lm, Luminaire input power: 52 W, Luminaire efficacy: 125 lm/W, CCT: 4000K, Lifetime: 50.000hrs @L80, Colour Rendering: CRI > 80, Chromaticity tolerance (initial MacAdam): 5, Impact strength: IK08, Tool-free installation, Conduit entried, BESA compatible. Available accessories: Plug&Play Emergency kit for 3 hour emergency conversion (self- and manual test). Lumen package adjustable on site by 3 steps (FLEX1: 6500 lm (52W), FLEX2: 5000 lm (39W), FLEX3: 3500 lm (26W)). Detailed power setting information available on www.THORNeco.com. Dimensions: 1504 x 71 x 81 mm, weight: 1.7 kg.

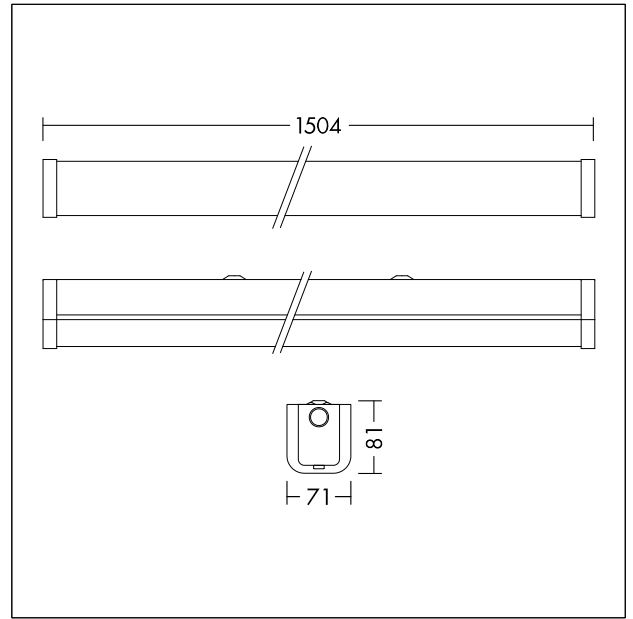

TE_POPPYF_F_LIT_PERS_1.jpg



TE_POPPYF_M_1500.wmf

Light Distribution

STD - standard

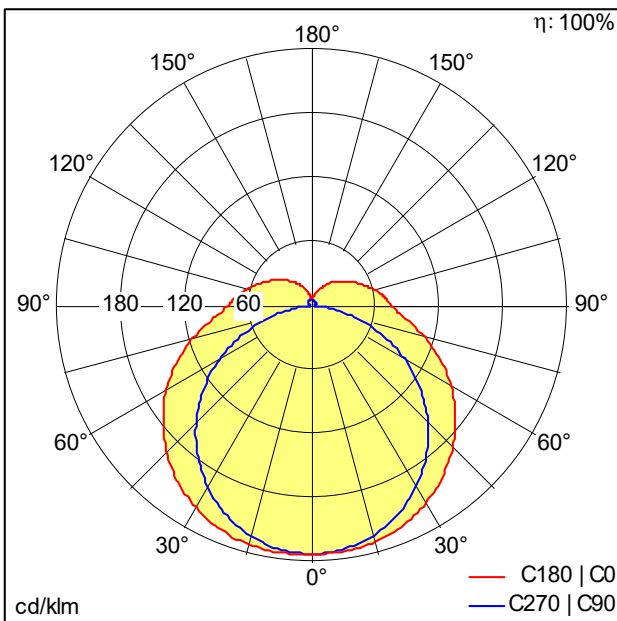

TE_POPPY_FLEX_1500_6500_840_FLEX1.idt

- Light Source: LED
- Luminaire luminous flux*: 6500 lm
- Total emergency luminous flux: 532 lm
- Luminaire efficacy*: 125 lm/W
- Colour Rendering Index min.: 80
- Correlated colour temperature*: 4000 Kelvin
- Chromaticity tolerance (initial MacAdam): 5
- Rated median useful life*: L80 50000 h at 25 °C
- Ballast: 1x LED_Con
- Luminaire input power*: 52 W Power factor = 0.9
- Dimming: Fixed output
- Maintenance category CIE 97: D - Enclosed IP2X
- Total harmonic distortion (THD): 20.00 %

This product contains a light source of energy efficiency class D.

All values marked with an * are rated values. Connected electrical load and luminous flux are subject to an initial tolerance of +/- 10%, the most similar colour temperature is subject to an initial tolerance of +/- 150K. Unless stated otherwise, the values apply to an ambient temperature of 25°C.