

Product Description	CCT(K)	System light output(Lm)	P(W)	Energy Efficiency Class of Light source	Dimensions (mm) L	A	Weight (kg)
ECOLINK NCF 4FT SINGLE 840	4000	2400	22	D	1207	660-880	1.1
ECOLINK NCF 4FT TWIN 840	4000	4800	44	D	1207	660-880	1.12
ECOLINK NCF 5FT SINGLE 840	4000	3500	31	D	1507	960-1160	1.28
ECOLINK NCF 5FT TWIN 840	4000	6800	53	C	1507	960-1160	1.32

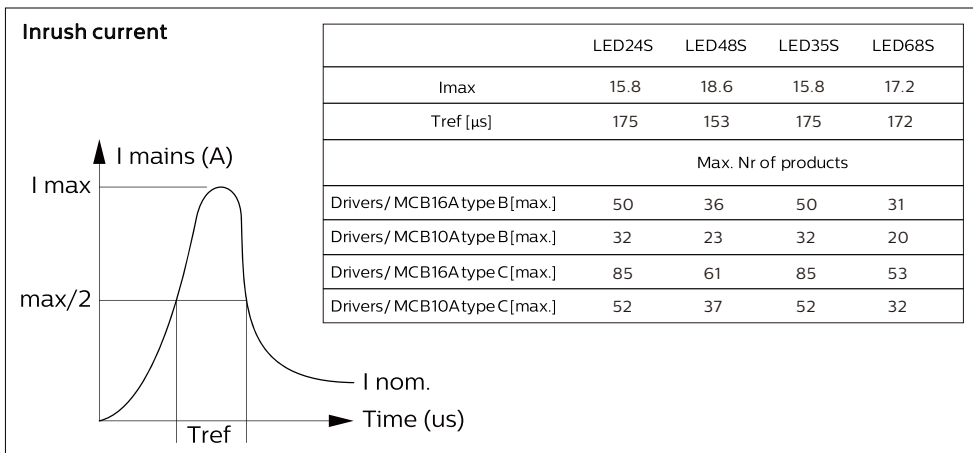

- The luminaire shall be installed by a qualified electrician and wired in accordance with the latest IEE electrical regulations or the national requirements. The light source contained in this luminaire shall only be replaced by the manufacturer or his service agent or a similar qualified person.
- Do not store/install/use the luminaire in corrosive environment with hazardous substances, e.g., sulphur, chlorine, phthalates etc., or on the location where it is exposed to conductive dust, heavily grease (esp. mineral oil or distillates, e.g., petroleum), heavily naphthenic treated with hydrogen.
- This product is not suitable for cold & humid storage areas, especially where obvious temperature gradients are present, such as ventilation opening, door, etc.
- Do not install the luminaire on the location where it is exposed to direct sunlight. UV radiation will damage the material over time, resulting in loss of waterproof sealing and IP65 rating.
- Do not stare into LED light beam.

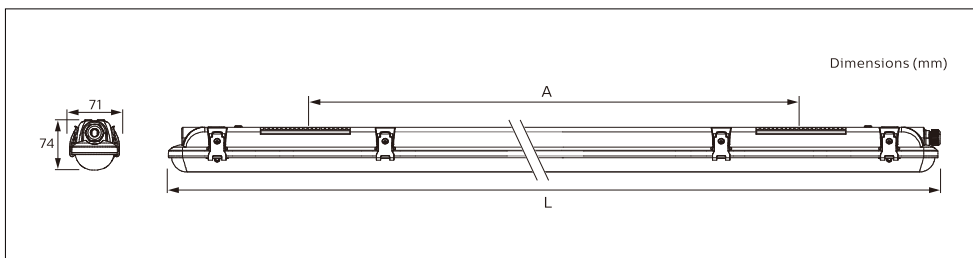
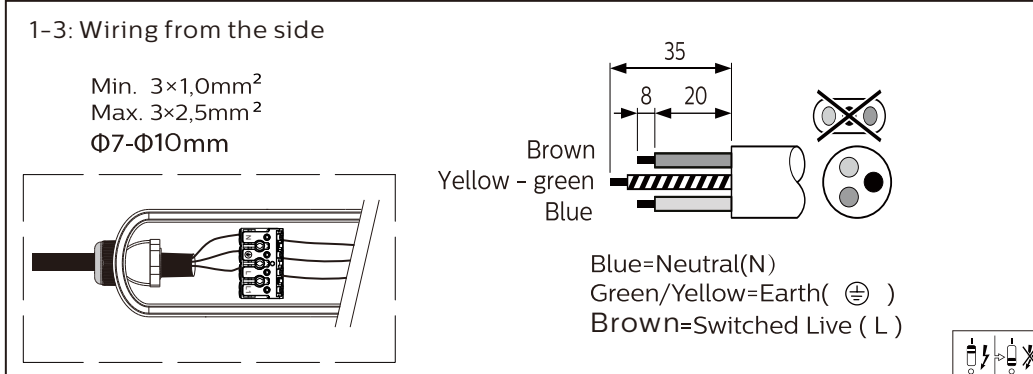
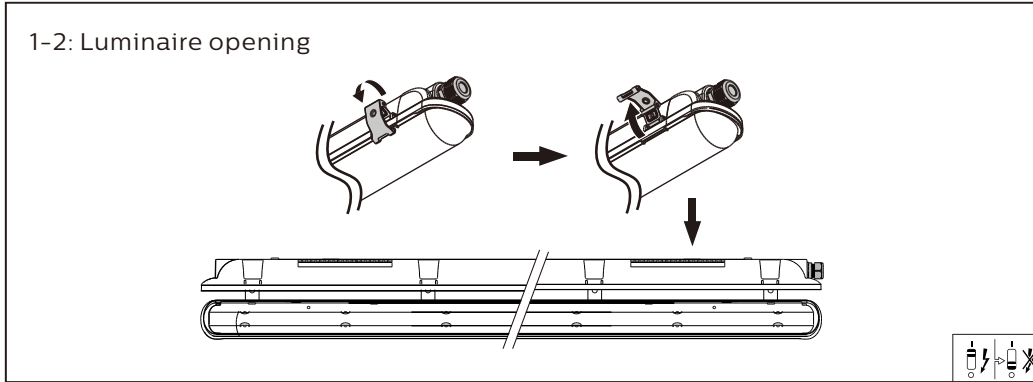
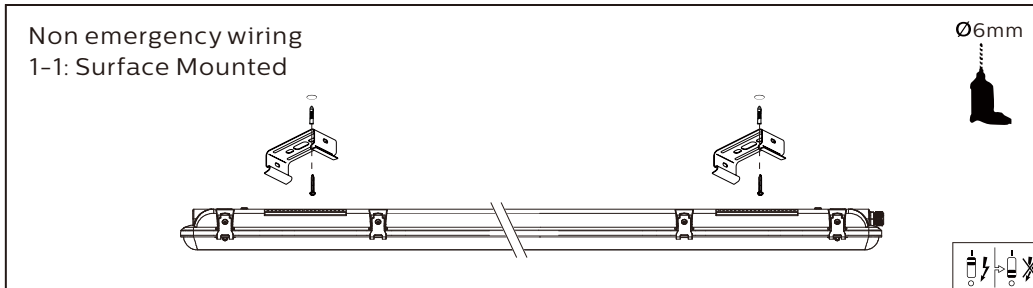
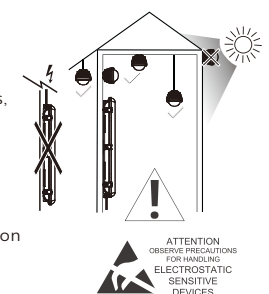

2-1: Emergency wiring

A Luminaire opening

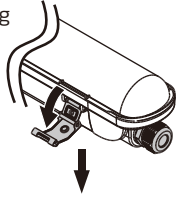

C Emergency LED installation

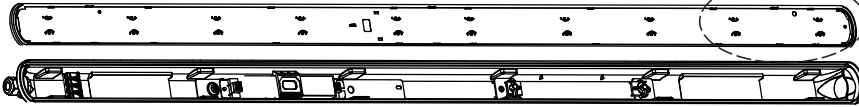
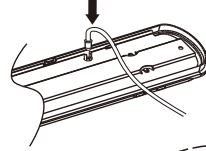

B Emergency installation

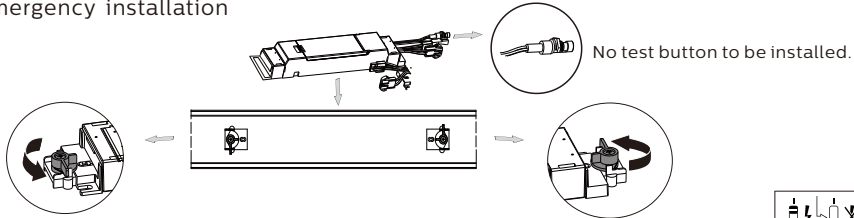

2-2: (option with additional emergency module EM300V)

Emergency Module:
 Follow manual instruction of EM300V
 Order Code: 912401483460
 EM300V ELP3 kit HV 6.4V 2000mAh LFP
 The emergency pack is not provided.



3 Log book



No tie wrap

2



1 Date of

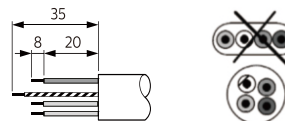
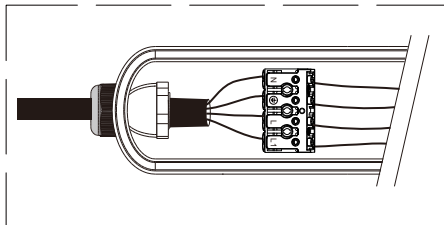
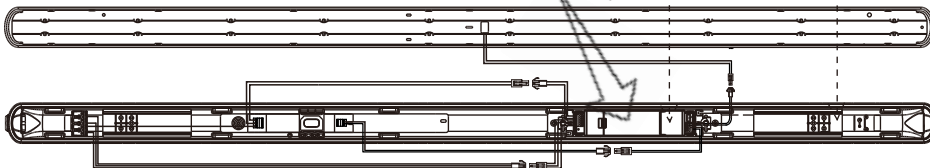
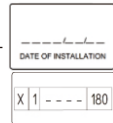

Blue=Neutral(N)
 Green/Yellow=Earth(⊕)
 Black =Switched Live (L1)
 Brown=Unswitched Live (L)



2-3:

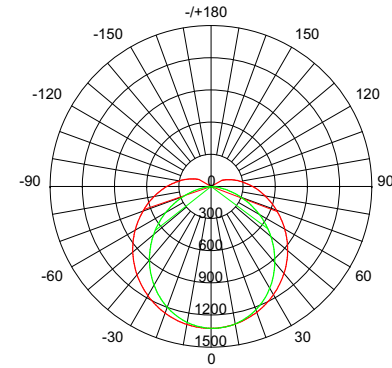

Rated lumen output in emergency mode: min 280lm

3: TW Optional

Warning/note! emergency wiring
 Through wiring cannot be combined
 with EM pack installation.

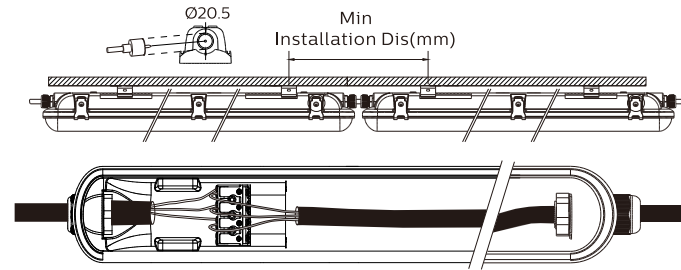

Type	Min installation distance(mm)
L1200	330
L1500	360



4: Close the luminaire

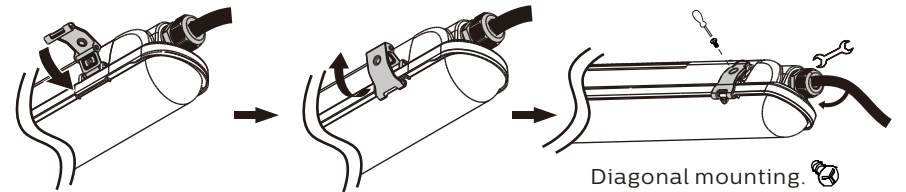

Diagonal mounting.

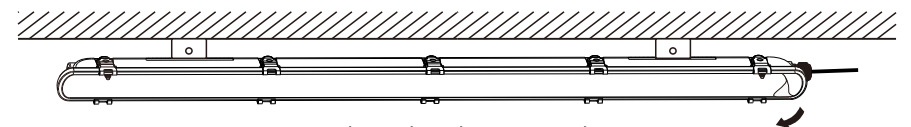

Foil needs to be removed.

