

Product Information

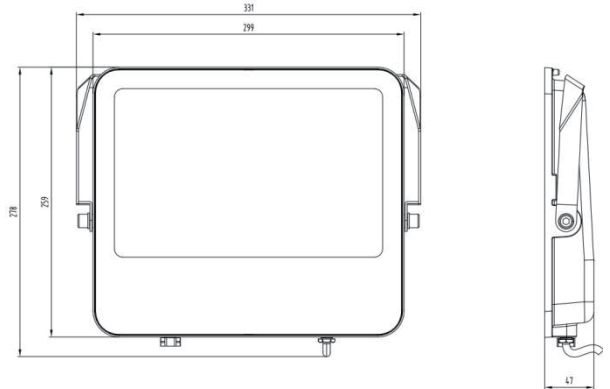

Technical Specifications:

Model	Voltage	Power	Displacement factor	Lumen	Beam angle	CCT	Lifespan	Cable	Dimmable	Dimension(mm)
S18412	AC220-240V	150W	≥ 0.9	18000lm	110°	5000K	50,000hrs	100cm	No	331x278x47

Driver Data Sheet

Driver date	Specification
Input rated Voltage	AC220-240V
Frequency	50/60HZ
Input Voltage	AC220-240V
Efficiency	90%
Totall Load wattage	150W
Displacement Factor	≥ 0.9
Rated input current	0.66
Full load output current	0.32
Rated output current	0.32
Output current range	$\pm 5\%$
Power tolerance	$\pm 10\%$
Current output tolerance	$\pm 5\%-10\%$
Withstand voltage	1500V
Short circuit protection	PASS
Overload protection	PASS
No-load protection	PASS

Fixture Compatibility

Rated Wattage	Electrical Classification	Ingress Protection	Operating Temp	Operating Humidity	Storage
150W	I	IP65	-20°C - +40°C	10-95%	-25°C - +65°C \leq 95%RH(25 best)

Spectral Distribution

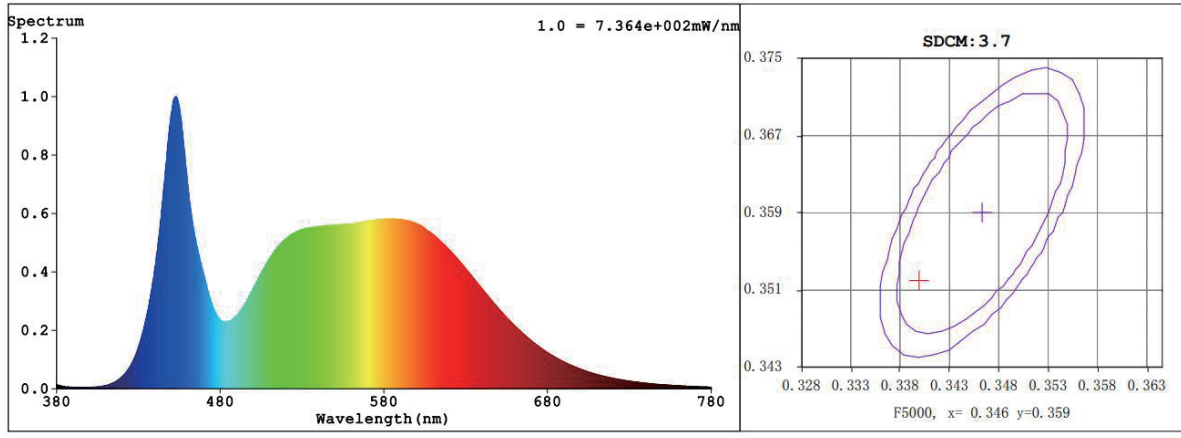

Photometric Diagram

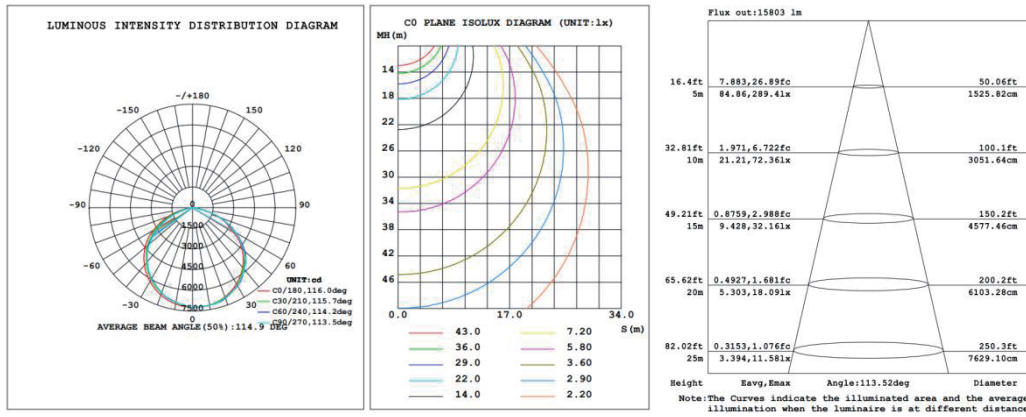

Planar Illuminance Curve

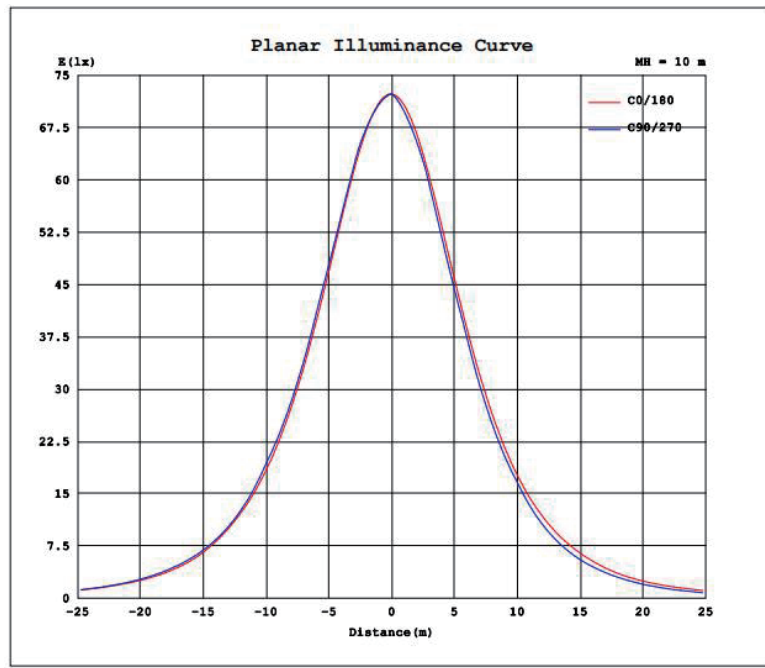

Installation

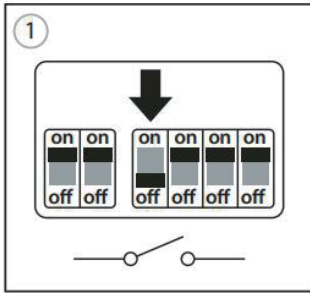

Switch OFF at mains supply before installing

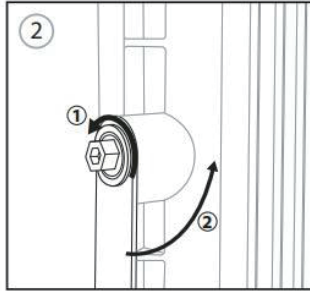

Loosen bracket but do not remove from the floodlight

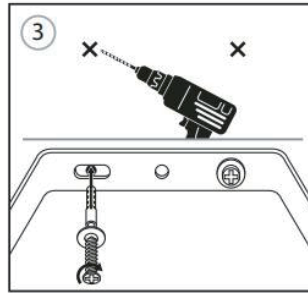

Mark the position of the bracket in the desired location. Avoid any concealed pipes or wires. Secure bracket in place with the screws and plugs provided.

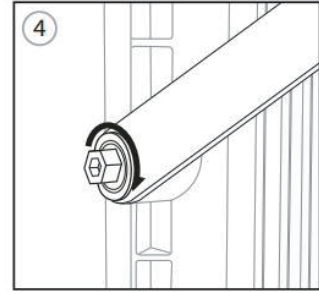

Tighten (do not over tighten) bracket when the floodlight is set to the desired angle.

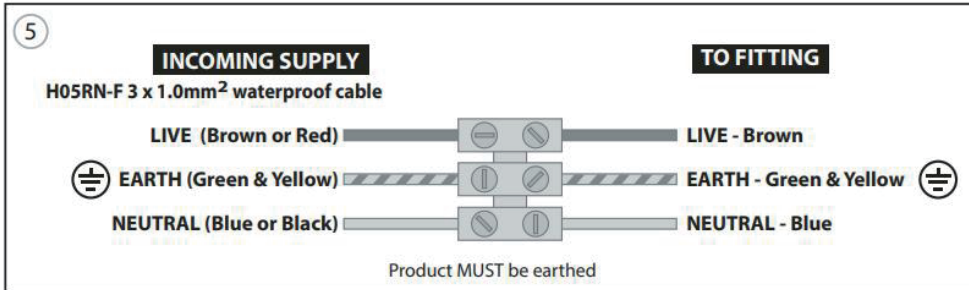

Insert correct supply (as above) into terminal block. Pre wired cable does NOT include connector. Once wired you must ensure that the connection is waterproof via a suitable IP rated connection box or with an adequate amount of insulation tape and located in a sheltered position.

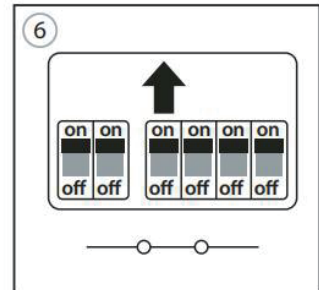

Return power. Switch ON at mains supply

Packaging Information

	Size(CM)	N.W/Pcs (KGS)	G.W/Carton (KGS)	Qty(PCS)
Carton	35X11.5X32	1.7	12	6

	CTNS	QTY(PCS)	VOLUME(CBM)
20" Standard container	2,173	13,038	28
40" Standard container	4,503	27,018	57.99

Packaging Information

EN IEC 60598-1:2021/A11:2022 EN 60598-2-5:2015 EN62493:2015/A1:2022
 IEC60598-2-5:2015 used in conjunction with IEC60598-1:2020
 EN IEC55015:2019/A11:2020 EN61547:2009 EN IEC 61000-3-2:2019/A1:2021 EN61000-3-3:2013/A2:2021
 EN IEC 55015, EN61547, EN IEC 61000-3-2 and EN 61000-3-3



RoHS
Compliant

